

GHA

'we reflect your excellence'

Info

RNI No.: UPBIL/2013/50547

www.ghglassmagazine.com

VOL : 11, ISSUE - 4 OCTOBER - DECEMBER 2023

INDIA's Fast Growing Magazine on Architectural Glass & Architectural Hardware

**GLASS New Definition
of Architecture**

Facade Technology

**Benefits of Aluminium
in Green Architecture**

Upcoming Events

Products Hunt

Latest News & Updates
in Glass Industry



RAZA MIRROR INDUSTRIES

Pvt. Ltd.

Eastern India's Biggest
Glass Importers &
Stockists

2A Kaviraj Row
Kolkata - 700073
Ph : 09830018811
Zahid@agoverseas.com

TRUCK & DIRECT PORT DELIVERY AVAILABLE



A M S G C O M P A N Y

NUWAVES GLASS



EXPERIENCE THE BEST QUALITY AND SERVICE IN:

- Architectural Toughened Glass
- Insulated Glass
- Laminated Glass
- Automotive Glass

NUWAVES GLASS PRIVATE LIMITED

(An ISO 9001:2015 Certified)

Regd. Office : SCO : 16-17, 2nd Floor, PPR Shopping Complex, Mithapur Road, Jalandhar-144003

Web : www.nuwaves.org Email : sales@nuwaves.org

Works : 44, Industrial Estate, Phase-I, Goindwal Sahib-143422. Distt. Tarn Taran, (Punjab)

Ph. : +91-84378-12333 M.: +91-87250-17403

1ST HAND AUTHORIZED SELLER OF XINFU PVB IN INDIA



- 3 Production Lines in China
- With Capacity of 6 Million Square meters
- **Architecture grade, Automotive grade, Solar grade**
- Transmittance 91%

Best Production Facility

- | | |
|--|-----------------------|
| Loss in weight Feeder | -- Brabender Germany |
| Screen Changers and Melt Pump | -- Maag, Switzerland, |
| Extrusion Die | -- CLOEREN USA, |
| The Online thickness scanner, Automatic gauge Control (AGC) Systems. | |
| Online scanning Moisture Tester | -- Honeywell USA, |
| The online surface vision test system | -- ISRA Germany, |

XINFU CUSTOMER MAIN MARKET

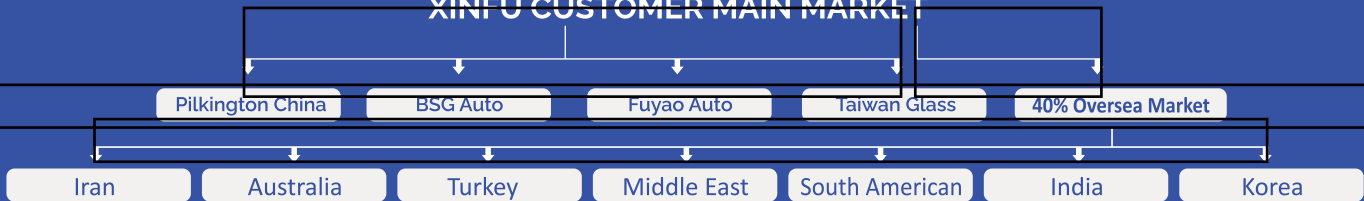

BLG INTERNATIONAL PVT. LTD.



FROM THE HOUSE OF
LAKSHMI FLOAT GLASS LTD.

SUPPLY
ALL OVER INDIA

Displayed at :

Redg. Office : A-2/30-31 Floor W.H.S.,
DDA Marble Market, Kirti Nagar, New Delhi
Mumbai Office : L-135, Midc, Taloja, Raigarh,
Maharashtra, Mumbai-410208, INDIA

Contact us @

adityagupta@blginternational.in,
www.lakshmifloat.com, sales@blginternational.in



Whatsapp us:
+91 99562 95454

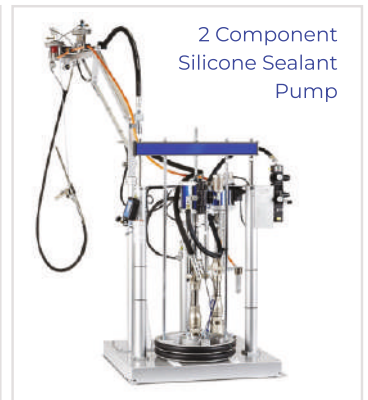
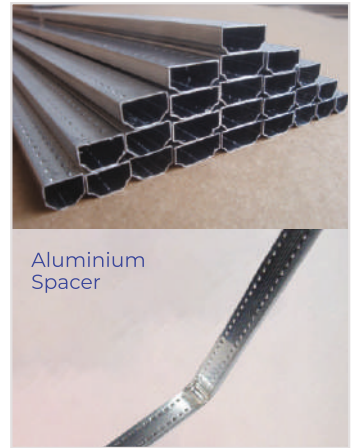

OUR PRODUCTS

PVB | EVA | VACUUM SILICONE BAGS | TEFLON MESH | FABRIC | INSULATING GLASS SILICONE SEALANT | FENZI BUTYL
 GLASS BLOCKS | FLOAT GLASS | MIRROR BULLET RESISTANT GLASS | PROCESSED GLASS & PATTERN GLASS | BUTYL TAPE | GLASS SEPARATOR
 GLASS PROCESSING TOOLS | GLASS PROCESSING MACHINES | **SentryGlas**[®] | **Trosifol**[®] | **ExtraStiff**[®] | **Butacite G**[®]

BLG INTERNATIONAL PVT. LTD.



FROM THE HOUSE OF
LAKSHMI FLOAT GLASS LTD.

SUPPLY
ALL OVER INDIA

Displayed at :
Redg. Office : A-2/30-31 Floor W.H.S.,
DDA Marble Market, Kirti Nagar, New Delhi
Mumbai Office : L-135, Midc, Talaja, Raigarh,
Maharashtra, Mumbai-410208, INDIA

Contact us @
adityagupta@blginternational.in,
www.lakshmifloat.com, sales@blginternational.in



Whatsapp us:
+91 99562 95454

150+ Satisfied Customers Accross INDIA

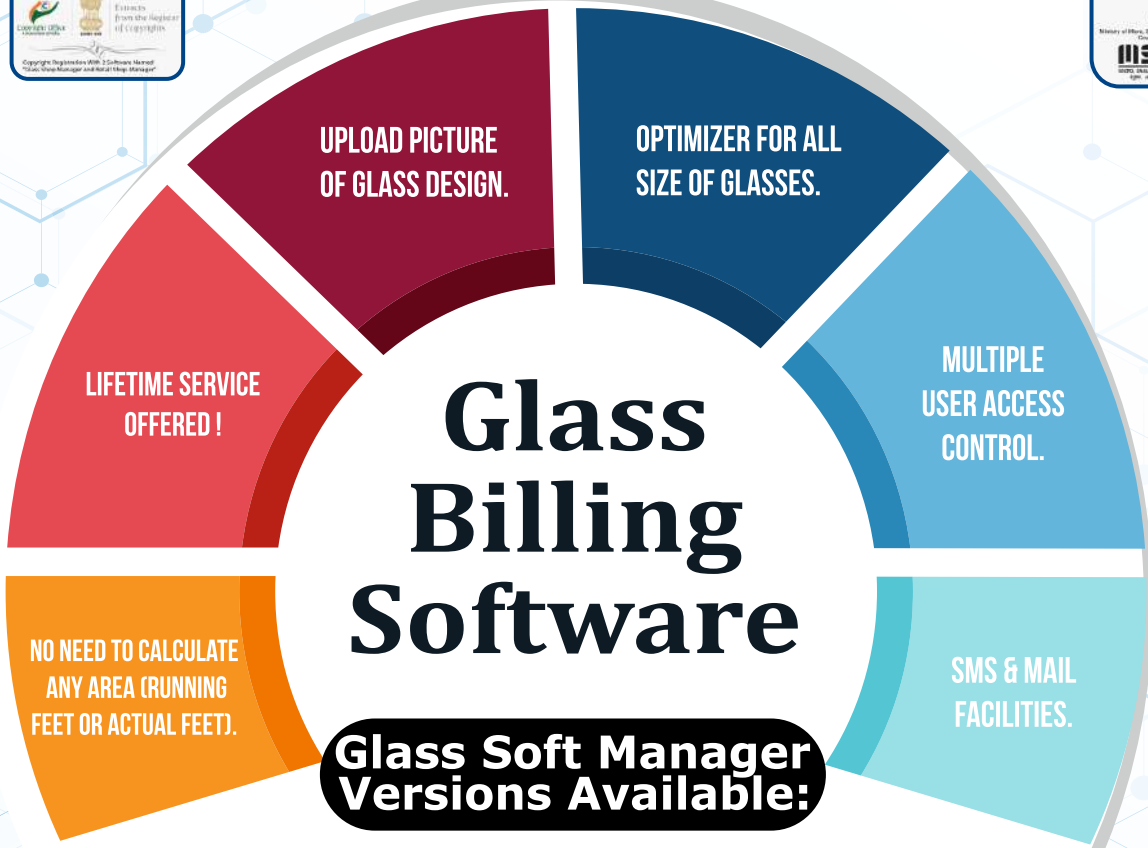

Home Edition

Glass Soft Manager Offline

Enterprise Edition

Glass Soft Manager + Hardware + Aluminum + Beet

All in One Edition

Tally Integration + Optimizer + G.S.T. Billing

TESTIMONIALS :



Kanch Ghar

"This Software completely change the business process of Chhattisgarh's Peoples, Time Saving, Quick Calculation, Perfection & Customer Satisfaction, Transparency of Billing. Good job. Thank you."



J.K. Glass Works Pvt. Ltd.

"Without Glass Billing Software we would be losing money & time. This software is amazing and support is second to none! I'm a 100% believer in Proximity IT Solution and after using it for 5 years, that speaks for itself. Thanks for a great system!"



DL Glass Agency

Proximity IT Solution is a great team to work with. They have a great team in technology. I highly recommend Proximity IT Solution to anybody who is looking for a Glass Billing Software that can handle things professionally.

Address : Shop No. - 501, 502, 503, 5th Floor, Karsan Chamber, Near Heritage Hospital, Devendra Nagar, Sec-2 Raipur, CHHATTISGARH - 492009

Contact : 98268 63173, 96691 73173, 95844 63173

E-Mail : support@proximityitsolution.com

Website : www.proximityitsolution.com



Service Area



Proximity IT Solution

"Software will not operate you, you operate the software!"

IS2553 : PART 1:2018



CML No. 5300056593



We make glass safer & better

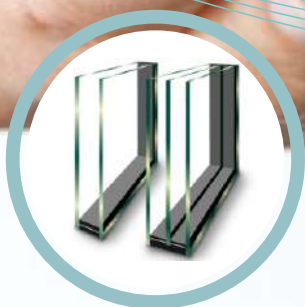

INSULATED GLASS



TEMPERED GLASS

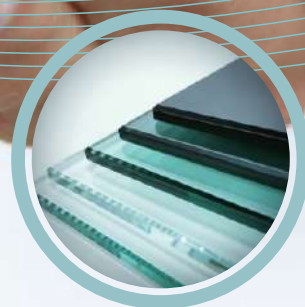

LAMINATED GLASS

VITRA INDIA GLASS PVT LTD

Jeevan Deep, G-6, Shyam Centre, Building, Brajkishore Path, opposite LIC, Patna, Bihar 800001

Phone : 097982 61462

 vitraindiaglass@gmail.com

 www.vitraglass.co.in

BEST PRODUCTS BEST CHOICE



acron

ARCHITECTURAL HARDWARE INTELLIGENT HARDWARE



Automated Door Sliding System



Floor Springs



Hydraulic Patch



Spider Fittings



Patch Fittings



Glass Routels



Shower Hinges



Sliding Roller Set



Glass Locks

DEALER ENQUARY SOLICITED

FLOOR HINGE/DOOR CLOSER/PITCH FITTING / DOOR HANDLES/SHOWER HINGE
SPIDER FITTINGS/ AUTOMATIC SENSOR DOOR/ SPIGOT RAILING

ACRON HARDWARE COMPANY

F-17 Office No. 101, First Floor, Subhash Chowk, Laxmi Nagar, New Delhi -110092
email : info@acronhardware.com | www.acronhardware.com | Mob. : 9810193200

GOLIVE



Glass Double Edger Machine



Automatic Glass Seaming Machine



Glass Washing & Drying Machine



L-shape Automatic Glass Production Line



Automatic Glass Seaming Line

GUANGDONG GOLIVE MACHINERY TECHNOLOGY CO. LTD.

Address : No. 11 ChengYe Road, Fengxiang Industrial Zone, Daliang, Shunde, Foshan City, Guangdong Province, CHINA

Mobile : +86 18033222596 | E-mail : situ@golive.cn | Http://www.golive.cn

PROVIDING
SAFETY BEYOND
IMAGINATION
THROUGH **INNOVATION**
AND **TECHNOLOGY.**



Birkan Engineering
Industries Pvt. Ltd



**TOUGHENED
GLASS**



**INSULATED
GLASS**



**LAMINATED
GLASS**



**SOLAR
GLASS**

Birkan Engineering Industries Pvt. Ltd.

S-4 & S-6, Site IV, Sahibabad Industrial Area, Ghaziabad-201010
Uttar Pradesh, India

Call : +91-9953364277 Ph. : +91-120-4225901 | 02 | 04

E-Mail : sales@birkanengg.com

Web : www.birkanengg.com

Follow Us On..





PRIME MAN GLASS

Deals In All Types Of Glass And Mirror

CLEAR FLOAT GLASS
ICE FLOWER GLASS
VENETIAN MIRROR
ANTIQUE MIRROR
GLASS MOSAICS
GLASS BLOCKS
FIGURED GLASS

REFLECTIVE GLASS
V - GROOVE GLASS
ACID / FROSTED GLASS
FANCY / BATH MIRROR
ACID TITANIUM GLASS
DEEP ACID ETCHED GLASS
LIGHT ACID ETCHED GLASS

ULTRA CLEAR SILVER MIRROR
SILK SCREEN PRINTING GLASS
COLOR MIRRORS 1.5MM - 5MM
ALUMINIUM MIRROR 3MM - 5MM
BACK PAINTED / LACQUERED GLASS



Khasra No. 93/1, (2-12) Alipur, Delhi -110036
Tel : 011-45730999 Mob : +91 7835-016-840 / +91 7835-016-845



Toughened Glass | Laminated Glass | Insulated Glass | Beveling | Stain Glass
Etching-Bend Glass | Shower Cubicles | Glass Furniture | Decorate Mirror
Lacquered Glass | Patch Fitting | Spider Fitting | All type of Glass Fabrication

Authorised Dealer :



Saurabh Agarwal : +91-8106508482 | Abhishek Agarwal : +91-9390628242, 8106612228

 **GLASS CONCEPTS**

#5-9-286/273A Rajiv Gandhi Nagar Industries, Prashanti Nagar, Kukatpally, Hyderabad, India
Phone : +91-9390628242, Call : +91-9490189816 | E-mail : glassconceptshyd@gmail.com

Website : glassconcepts.co.in | www.vedantglasssolutions.in



TM

Shiva-Tuff

Tempered In

SAINT GOBAIN SEVA FRNC

An ISO 9001:2008 COMPANY



The 1st Biggest **Branded Tempering Plant** in Punjab
Tempered by SAINT GOBAIN SEVA FURNANCE



The Pulse of Glass....

Shiva Tuff Advantages :

- Tempering Line Maximum Size 2440 X 4880
- AN ISO 9001:2008 Certified Company
- Jumbo Size Plant
- Prompt Delivery

Manufactured By :
Shiva Glass Industries Pvt. Ltd.
 Kohara - Machhiwara Road,
 Village Rayian, Distt. Ludhiana
 E-mail : orders@shivatuff.com
www.shivatuff.com
 Ph.: 7087-999991/2/3/4



C o n t e n t s

G.H.A. Info

RNI No. : UPBIL/2013/50547
Vol. : 11 Issue-4,
October - December 2023
www.ghaglassmagazine.com

Publisher & Editor

Sumit Sharma

Sr. Executive Editor

Ms. Tanuja Sharma

Asstt. Editor

Kuldeep Sharma

Legal Advisor

Yogendar Singh Tomar

Graphics Designer

Punit Singh

Cameraman

Arvind Kumar

Leali Vetri Invests in LiSEC TPA Line



EURASIA DOOR, EURASIA GLASS AND EURASIA WINDOW FAIRS

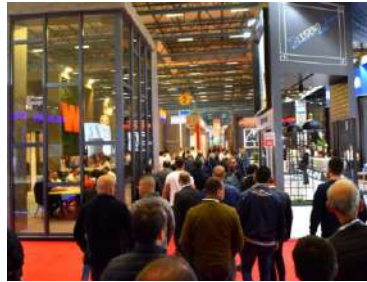

NGA Glass Conference Kicks Off in Isle of Palms, South Carolina



HEGLA at Fensterbau Frontale : People in focus



Energy Efficient Insulated Windows with ENERGY STAR® 7.0 Requirements



G.H.A. INFO. is Owner Publisher & Printer : Sumit Kumar Sharma, **Printed by :** Progressive Offset Printers, Vaishali Colony, Garh Road, Meerut-250 001 and Published at : 224, Vaishali Colony, Garh Road, Meerut-250 001, (U.P.) INDIA
Editor & Publisher : Sumit Kumar Sharma



PGT Innovations announces new glass company, customer base, and facility in Virginia

www.ghaglassmagazine.com

Download Free E-magazine

Office : K-4/4029-30, Shastri Nagar, Meerut-250004, (U.P.) INDIA

Mobile/WhatsApp : +91-9027622727 | E-mail : ghainfo2012@gmail.com | Website : www.ghaglassmagazine.com

Importers of All Types of Glass WE SUPPLY ALL OVER INDIA



Glass Pillars

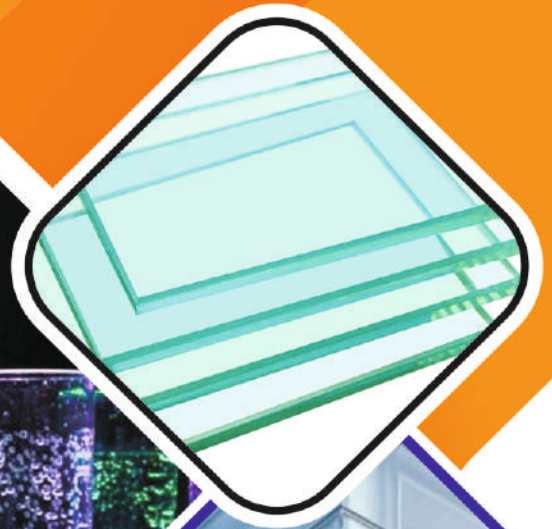

WHOLESALE DEALERS :

- ★ Clear Float Glass
- ★ Decorative Glasses
- ★ Reflective Glasses
- ★ Color Mirrors
- ★ Mirror from 1.5mm to 5mm
- ★ Extra Clear Float
- ★ Silk Printed Designs
- ★ Pattern Glasses
- ★ Back Painted Glasses or Lacquered
- ★ Temperable Designer Series
- ★ Moru and Flutelite Pattern Glasses
- ★ Glass Pillars
- ★ Glass Blocks
- ★ Architectural Hardware (KYLO)



BHANDARI GLASS COMPANY

5-3-496, Old Topkhana Road, Osmangaunj,
Hyderabad-500012, Telangana, INDIA

M: +91-98496 11100

E: bhandari_glass@yahoo.co.in

Mayurglass@yahoo.in



Mayur Glass House

Part-3, B-9 and 10-B Block, Autonagar, Gajuwaka,
Visakhapatnam-530012, Andhra Pradesh, India

M.: +91-99487 06820, +91-98488 33000

E: mayur_glass@yahoo.in

Info.mayurglass@yahoo.com

GlassWare®

Premium Architectural Hardware

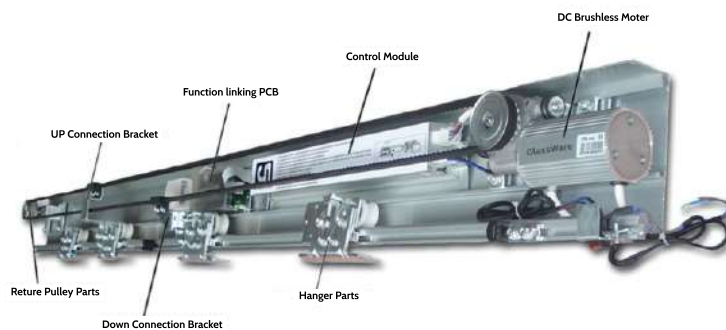

Harsh Jain (Director)
+91-9999014335

Ankit Jain (Director)
+91-8130395851

MANAN INDUSTRIES LLP

Warehouse : Kh. No. 33/12, Main Bawana Road, Samay Pur Badli, New Delhi-110042
Works : GL-42, Ganpati Dham Industrial Area, Bahadurgarh, Haryana-124507
E-mail : mananindustriesllp@gmail.com Web.: www.mananindustriesllp.com
Customer Care No. : +91-8700061600



CloZex®

LEGENDARY RELIABLE
ARCHITECTURAL GLASS HARDWARE

FLOOR SPRINGS & COMBO SETS

5 YEAR GUARANTEE

- Certified Products 
- Designed As Per European Standards
- Premium & Luxury Glass Hardware Concepts
- Elegant Designs
- Prominent Appearance
- Eminent Quality



SS304 PLATES WITH WATER PROOFING GASKET



TOP & BOTTOM PATCH
SS304 PLATES WITH
STEEL INSERTS



PATCH LOCK SS304 PLATES
WITH BRASS KEYS
& CYLINDER



DUAL TONE HIGH
STRENGTH HANDLE
WEIGHT APPROX. 1.2 KG



D LOCKS WITH
BRASS KEYS



SLIDING ROLLERS SS304
A2 AVAILABLE IN
MATT & CP POLISHED



HEAVY DUTY SS304
SHOWER HINGES

ALL GLASS HARDWARE ITEMS & DOOR CLOSERS AVAILABLE

 Everest industries
Since 1987

(Office -1) 44 New Industrial Estate Jalandhar, Pb.
(Office -2) Paharganj, Delhi
everestindustries44@gmail.com  97800-34340 

ALL INDIA DELIVERY AVAILABLE

Flat Toughened Glass from the most advanced
Modern Technology Toughened Glass Plant in Noida
Plant Size : 2440 mm × 3660 mm (8'×12')



Radha Tuff

Toughened

OUR THRUST

- BEST QUALITY
- BEST PRICE
- BEST DELIVERY
- FRIENDLY AMBIENCE

Located in the heart of Noida at Sector-2 just
2 km. from DND flyover and Mayur Vihar, Delhi.

Processors of

- Building Exteriors & Interiors Glass
- Security Glass
- Frameless Glass Doors
- Shop Fronts
- Shower Cubicles
- Bullet Proof Glass
- Furniture Glass
- Sky Light
- Canopies
- Glass Railings
-and many more applications



Manufacturer of : Toughened, Insulating & Laminated Glass

S.G. INDUSTRIES

Works/Office : D-23, 24, Sector-2, Noida 201301 (U.P.)

Tel. : 0120-4320689, 4320889, 4320989, Fax:0120-4320489

E-mail : sgindustriessglass@gmail.com, info@radhatuff.com, guptasharad27@yahoo.co.in

Website : www.radhatuff.com

For any sales enquiry

Mr. Sharad Gupta (M.D.)

Mob. : +91-8800390185,
+91-9810010689

Mr. Kapil Chauhan

Mob. : +91-8800390181



ARCHITECTURAL
G L A S S
H A R D W A R E

Manoj : 9899607360
Upadesh : 8860865327



AN ISO 9001-2015 Certified Company

Manoj Trading Co.

(DorMX Hardware)

C-161, Ground Floor, Sector 25, Rohini, New Delhi-110085
E-mail : cmanoj073@gmail.com | Web : www.dormxhardware.com
Customer Care No. +91-8860865327, 9899607360
<https://dizitalcard.in/dormxhardware/>



Make your Dream,
More Secure now with



World Class Flat & Bend Tempered Glass **OROTUFF GLASS PVT. LTD.**

North India's Leading One Wholesale Business House

Authorised Wholesale Dealers & Stockist



Gujrat Guardian Ltd.



Asahi India Glass Ltd.



Saint-Gobain Glass India Ltd.



Gold Plus Glass Industries Ltd.



HNG Float Glass Ltd.



XL-C®

- Automotive
- Architectural
- Solar
- Furniture
- And Other Diversified Applications
- Architectural Bend Glass



Sister Concern

OM GLASS COMPANY

Corp. Office : G-44, Sector-9, Noida-201301 (U.P.)

Phone : 0120-3067799, Fax : 0120-4359196 | Mobile : +91-9811117510, +91-9311631195

E-mail : ombeer@orotuff.com, omglass2011@gmail.com, Omglassco@gmail.com | Website : orotuffglasses.com

Work : E-62, Site-B, Industrial Area, Surajpur, Greater Noida (U.P.)

Branch Office : Delhi, Haryana, Punjab



Glassma India

...Exclusive Designer Glasses

Office :
5C/9, New Rohtak Road, Near Liberty Cinema,
Karol Bagh, New Delhi-110005 (Inida)

Vishwas Kapoor : 9910098333
Pawan Singh : 9266707810
Mukhtar : 9311145626
E-mail : glassmaindia@gmail.com
Website : www.glassmaindia.com

Our New Range of Designer Glasses



Lacquer Colours



Antique Mirror Collection



Gold leaf and Marble Series



Luster and Titanium Series



Glassma India is one of the leading manufacturer, Importer & Supplier of exclusive Designer mirrors which include Touch Sensor Led Mirrors, 3D Mirrors, Modern Cut Work Mirrors, SS Frame Mirrors & other Economical Imported Mirror Range. Our products are very widely used by Architects & Interior Designers for House Interior, Commercial Interior, Showrooms, Hotels etc.



Toughened Plant



Polish-Buff-Machine



Glass Groove Machine



Air-Compressor



Glass Grinding Machine

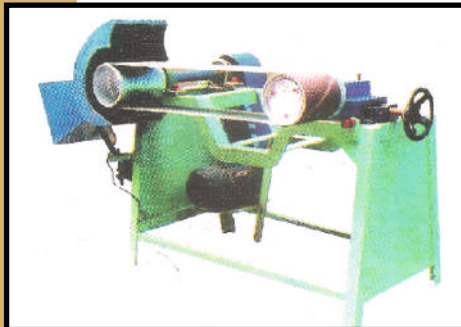

Glass Grinding & Polish Machine-Day Belt



Including exhaust Fan

Flat & Bend Toughened Plant (Auto/Semi), Safety Plant (Auto/Semi), Folding Hi-Polish Glass Grinding Machine, Mirror Plant, Glass Putti Plant, Distilled Water Plant (Mirror), Drilling Machine, Grinding Water Belt Machine, Water Grinding Machine (Group & Khadda) Glass Polishing Machine (Mirror), Buffing Machine Washing Machine, Beveling Machine, Glass Cutting Machine, Groov (Khadda) Machine, Engraving (Flower) Machine.



Vijay Glass Machinery Works

Office : 3, Ambica Mukherjee Road, (Near State Garage) Kolkata-700 056, West Bengal, India Residence : 156/1/1, B.T. Road Dunlop, Kolkata-700 035, West Bengal, India Phone : (O) +91-033-25645361, Mobile : +91-98300 37619, +91-98300 43891, Email : vijayglassworks@yahoo.com, Website : www.vijayglass.com

Associate Firm :



Ajay Glass Engineering Works

156/1/1, B.T. Road, Dunlop, Kolkata-750 035 (West Bengal) India. Website : www.ajayglass.in

HISENG MACHINERY

MAKE YOUR
WORKS MORE EASY!

HISENG 海盛

海盛机械, 令你工作更轻松!

- ✓ Automatic measuring glass size
自动检测玻璃尺寸
- ✓ Smart operation
智能操作
- ✓ Supper fast working speed
高速磨边



SPECIALIZED IN :

Double
Edger

Vertical
Edger

Beveler
Machine

Washing
Machine

Drilling
Machine

SHUNDE HISENG GLASS MACHINERY CO.,LTD. ,

佛山市顺德区海盛玻璃机械有限公司

E-mail: sales@hsglass.com.cn www.hsglass.com.cn ☎ 0086-13922166837



Quality you
can measure

FLOAT GLASS
EN ISO 9001:2008



S. Joginder Singh : 9915816039
S. Ajit Pal Singh : 9803838388

- Toughened Glass
- Laminated Glass
- Insulating Glass
- Security Glass
- Bullet Proof Glass (Armour Glass)
- Wind Shield Glass for Busses & Cars
- All type of Bend Glass

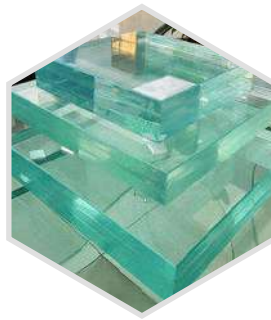
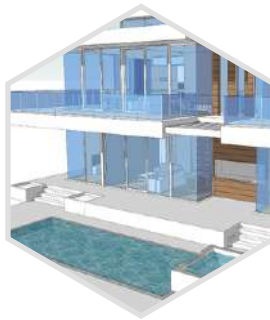

J.K. Toughened Glass Works

#27, J.K. House, New Industrial Estate, Jalandhar (Punjab)
Tel.: 7527006201, 7527006202, E-mail : jktuff@hotmail.com
Website : www.jkglasses.in



MATRIX

T/G

IS 2553 PART1

Float Glass From



CML-6600078612

SAINT-GOBAIN



- Toughened Glass • Heat Strengthened Glass • Laminated Glass • Insulating Glass
- Security Glass • Bullet Proof Glass (Armour Glass)



MATRIX

GLASS INDUSTRIES

R.S. No. 84/10, G.Konduru Mandal, Vijayawada,
 Krishna, Distt.A.P. India-521229
 E-mail : info@matrixglassindia.com
 Web : www.matrixglassindia.com
 Contact us : 7330693457



IMPORTERS OF

- ★ Clear Float Glass
- ★ Decorative Glasses
- ★ Reflective Glasses
- ★ Color Mirrors
- ★ Glass Pillars
- ★ Glass Blocks
- ★ Pattern Glasses
- ★ Extra Clear Float
- ★ Silk Printed Designs
- ★ Back Painted Glasses
- ★ Temperable Designer Series
- ★ Moru and Flutelite Pattern Glasses

Authorised Dealer :



MAHAVEER GLASS COMPANY

Opp. Old Bus Stand, M.G. Road, Vijayawada-520 002 (A.P.)

E-mail : mahaveerglasscompany@yahoo.in

Arihant jain (Montu) : 9440024240 Ankush kumar jain : 9866123143



EVENTS

The 20th edition of ZAK GLASS TECHNOLOGY EXPO 2023, one was a grand success and emerged as one of the most trusted and popular platform for those who deal in this sector. The participants of this exhibition are well aware of its importance and wide reach because of which a high number of companies participated with full enthusiasm this year. People from around the world showed great enthusiasm and made the event a grand success. The expo started from 23rd November to 26th November in Bombay Exhibition centre (NESCO). The number of trade visitor showed an increase of 15% which is far more than that of the last year. More than 300 Exhibitors showcased their products and services and more than 20000 visitors visited the exhibition. The visitors looked satisfied and the exhibition provided them a range of options to choose from. In fact this year was one of the most successful year in comparison to last exhibitions. It was one of the largest show which experienced a large number of visitors and exhibitors from around the world.

The main focus of the exhibition was to showcase variety of glass hardware, accessories, tools and processing machine. There were number of new and innovative products which were displayed by a variety of companies. the whole exhibition was spread in an area of 40,000 sq meters and more than 320 companies participated from across 27 countries. there was comparative increase in European and Chinese exhibition in comparison to last year. The main aim of the exhibition was to showcase all the sectors related to glass production, processing technology on one platform. The visitors said that the exhibition has come a long way both in terms of varieties and options. The presence of market leaders and share of Indian and overseas exhibit creates number of opportunities for both the visitors and exhibitors. Indeed the exhibition served as a great platform for the development of industry and proved to be an important place for those involved in this business. The exhibition as it always, filled the glass and glazing industry with a new enthusiasm and energy.





ABOUT ZAKGLASS EXPO

Zak Glass Technology Expo is the leading glass technology trade show in India and South Asia. This show provides the glass industry a single platform to showcase their products and to get variety of options with a number of companies that relations with a humber of companies that visit the fair. The core strength of ZAK is acting as a bridge between the buyer and the seller. Every event has been a resounding success and in line with our objective of maintaining international standards in organizing high quality professionally-managed and value-added exhibition. ZAK has orgnized over 100 jewellery exhibition all over India and abroad and also organized, Second international furniture fair in Chennai.

It is one of its kind to create platform for people who are involved in variety of business to provide a single platform so as to provide them a wide opportunity for the success of their work. It also

serves as the first exhibition organizer from India to organize Garmentech in Bangladesh and Sri Lanka.

Zak holds a record for organizing three international exhibitions of different Industries concurrently on same dates and now it is all again set to organize India's ever largest International Glass and Glazing Technology show at Pragati Maidan, New Delhi this year.

Zak acts as a bridge between buyers and sellers and hence creates opportunities for its exhibitors to learn new things and to remain update about every new technology which is hitting the market. In past few years the response towards this exhibition proved its acceptance among people and showed how much they are in need of such a high scale exhibition which can create better business platform at International level. It provides launch Pad for new products and innovations.









Leali Vetri Invests in LiSEC TPA Line

Leali Vetri and LiSEC - a long-term, successful partnership

Leali Vetri srl has been manufacturing insulating glass and glass for interiors since 1972. The company is based in Castiglione delle Stiviere, a town in Lombardy, and employs around 30 people. Company founder Bruno Leali passed on his passion and expertise to his son Maurizio, who continued and expanded the business, moving it to a larger factory in 1986. Back then, the company had already earned an excellent reputation for quality, experience and reliability in the installation of art glass. 1990 saw the

company start to manufacture thermal insulation windows with triple insulating glass, which was enjoying high demand in the construction sector. In 2010, Leali Vetri srl (with one partner) built a new company headquarters with state-of-the-art technology for the production of glass products that satisfy the market requirements for sustainable construction. Looking to the future, Leali Vetri has now acquired a LiSEC TPA line for the manufacture of thermoplastic spacers.



FOR LEALI VETRI, THE KEY TO SUCCESS LIES IN LOCAL BUSINESS

The company strives to offer its customers – including construction companies, window manufacturers and interior designers – high-quality service. Leali Vetri supports its customers in the selection, production and installation of products using leading edge materials and solutions. The Italian company focuses on the local market and sells its products within a radius of 300 kilometres of its headquarters. As proprietor Maurizio Leali explains: "This enables us to offer our customers unbeatable after-sales service, because we are able to process inquiries quickly and efficiently. Our

main business is the manufacture of thermal insulation glass and glass for construction projects, which accounts for 80% of our turnover, while the remaining 20% is generated by the sale of glass for indoor use. We value the feedback and satisfaction of our customers and we are always ready to respond to their needs and expectations. We are also open to new opportunities and challenges because we are constantly working to expand our customer base and increase our market share." For Leali Vetri, when it comes to the company's products, quality is more important than quantity. Automation is essential to remaining competitive in a constantly changing market, which is why Leali Vetri endeavours to automate the majority of its processes.





LEALI VETRI AND LISEC : A LONG-TERM, SUCCESSFUL PARTNERSHIP

Cooperation with LiSEC began back in 2000 with the procurement of a semi-automatic butyl extruder for rigid frame spacers (LBH-25V) and an automatic filling machine for desiccants (A1RL). Over the years, Leali Vetri has been more than satisfied with the durability and high quality of the LiSEC products used in the

Castiglione delle Stiviere plant. The LiSEC VL-1N sealing machine acquired in 2002, for example, remains efficient after more than 20 years in use. For Leali Vetri, LiSEC is an innovative, competent and reliable partner that contributes to increasing productivity, improving competitive advantages and reducing operating costs. In 2022, Leali Vetri srl acquired the innovative LiSEC FlyOver gantry loading system, which covers an automated warehouse with around 100 items. Due to the design of the suction bridge, the system can move diagonally above the glass storage racks when empty. Once a coated sheet has been unloaded, the suction bridge can immediately move towards the next glass storage rack and the loader can be tilted down instantly. This process allows minimum cycle times, as the suction bridge does not have to move out from in between the racks after each cycle. Following this acquisition, a combined glass cutting line with a 6-metre bridge was also purchased. The Italian company additionally appreciates the good collaboration with the sales representative, who arranged for them to witness a LiSEC TPA line in action before considering an investment.



NEW TO THE PRODUCT RANGE IN 2024 : INSULATING GLASS UNITS MANUFACTURED ON A LISEC TPA LINE

"We believe that the thermoplastic spacer is the product that the market and customers need, especially when it comes to environmental impact. The greatest advantage of this technology is the reduction in resources realised at every level. Less material is required to produce the spacer, waste is reduced and storage requirements are lower. Furthermore, the performance of thermoplastic spacers is better than that of conventional spacers," explains Leali Vetri's Managing Director.



The company has invested in a LiSEC-TPA line capable of processing shapes and quadruple insulating glass in order to facilitate production of thermal insulation windows with thermoplastic spacers from the beginning of 2024. This line consists of the LiSEC KSD-A, VHW-F, RSVN, TPA-A, FPS-A and VFL-1F. The KSD-A from LiSEC is currently the fastest

vertical seaming and grinding machine with peripheral discs for glass edge processing available on the market. The VHW-F washing machine ensures that the glass is cleaned before being transported to the frame assembly station with inspection station (RSVN), which recognises impurities and glass defects. The TPA-A ensures seamless application of the thermoplastic spacer with optimised cycle times. The glass sheets are then transported to the FPS-A gas filling press, where they are pressed into insulating glass units. The final station in the Leali Vetri line is the VFL-1F, a fully automatic sealing robot that guarantees the highest quality corners



The entire line is controlled by LiSEC software. LiSEC Line Management enables the production of complete orders with different insulating glass combinations in a single step, while the line also has information on steps and shapes. The GPS.perfectscan quality scanner monitors each individual glass sheet and insulating glass unit for visible defects, resulting in higher product quality.



ELITE Glass Emporium

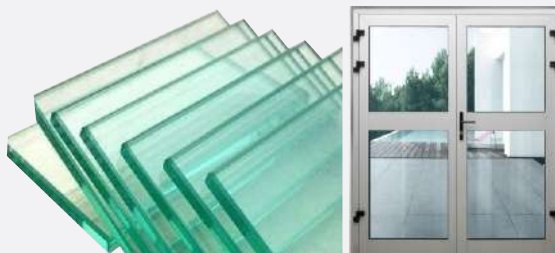

Rajiv Kumar Verma
(S) 0181-2405537
(M) 9872942021

All Kind of :

Glass, Aluminium, Taff Glass & General Order Supplier

Adda Bastian, Basti Road, Jalandhar City

Tim Widner Shares Insights on Glaston Machinery at Lippert Components

Tim Widner at Lippert Components in the US is sharing his and his team's experiences working with the Glaston glass processing machinery.

Glaston was our first stop. We consider Glaston to be a one-stop shop service provider. Now that they've added integrated cut-break-grinding cells and the ability to batch and load through the furnace, we really didn't look anywhere else other than a washer for where to get our equipment.

The new equipment has been a great addition to us. We are able to one-piece flow our raw material through our line, hands-free. No humans come in contact with the glass until it is fully tempered

and at the end of the process." processing line has made it possible to automate a large part and production is now significantly faster and more efficient." He adds: "We have also been able to build up know-how in the operation of the systron proHD over the last few years. Moreover we are also very satisfied with the smooth operation and consistently top quality of the processed glass."



SAINT-GOBAIN
GLASS INDIA

SHREE BALAGI GLASS & PLYWOODS

Deals In : Complete Range of Architecture Glasses

- Toughened Glass
- Designer Glass
- Security Glass
- Shower Enclosure
- Insulated Glass
- Patch & Spider Fitting etc.

37/3, (New No. 25) Devaraja Mudali Street, Chennai - 600 003
Cell : 9282208205, Ph.: 42624479

EURASIA DOOR, EURASIA GLASS AND EURASIA WINDOW FAIRS



The Center of the Construction Industry Supply Chain

Organized by RX Tüyap in collaboration with the Window and Door Sector Association (PÜKAD), Window Producers Quality League Association (PÜKAB), and Entrepreneur Aluminum Industrialists and Businesspeople Association (GALSİAD), the leading specialized fairs in Eurasia, Eurasia Door, Eurasia Glass, and Eurasia Window Fairs, set to visitors at the Tüyap Fair and Congress Center in Istanbul from November 16 to 19, 2024.

These trade fairs, which play a crucial role as a supply center for the construction industry, with the distinction of being the second largest trade event in the world and the largest in the Eurasian region, bring together leading

manufacturing companies with buyers from a wide region, particularly Europe, the Middle East, Central Asia, as well as North Africa. On the other hand, exhibiting companies can launch new products and establish new business collaborations during the fair.

3 Fairs Under One Roof :

Simultaneously organized, the 25th Eurasia Window, 16th Eurasia Door, and 14th Eurasia Glass Fairs present complementary solutions of the three industries under one roof, offering a wide range of products. Visitors will have the chance to explore the products and solutions of hundreds of exhibiting companies firsthand, creating new business connections

Tailored Made Solutions for All Needs Await Fair Visitors

At the 25th edition of the Eurasia Window Fair, visitors will meet with the most suitable and reliable suppliers and brands representing thousands of products. The fair will showcase window products, window profiles and processing solutions, window mechanisms, profile processing and window manufacturing machines, auxiliary equipment, window systems, shutters, complementary products, raw materials, facade and insulation systems, and an Aluminum Special Section that include aluminum windows, profiles, facade systems, aluminum accessories, and production machinery. In addition to that in the Shading Special Section, exhibitors will exhibit their products in the areas of roller blinds, tents, awnings, gazebos, and winter garden systems for four days.

At the 16th Eurasia Door Fair, door products, PVC, shutters, panels, partitions, door accessories, and door technology manufacturers will introduce their products and services to the fairgoers. The 14th Eurasia Glass Fair will bring together industry professionals with glass products and applications, production-processing technologies, and machines, as well as complementary products and chemicals.

Record Participation in 2023

In 2023, the fairs, broke a record with the participation of 620 companies and company representatives in the entire 120,000 square meters of exhibition space, hosted a total of 56,398 industry professionals, including 12,988 international visitors from 122 countries and 43,419 visitors from Türkiye. Berkan Öner,

General Manager of RX Tüyap, noted that this record interest reflects the magnificence of the industry.

“Eurasia Door, Glass, and Window Fairs : Supply Center for the Construction Industry”

Continuing to emphasize the importance of the fairs for the construction industry, Mr. Öner stated, "Eurasia Door, Eurasia Window, and Eurasia Glass Fairs undertake the role of a comprehensive business hub for domestic and international companies, bringing together three industries. Especially due to their contributions to the supply chain in the construction industry, our trade shows hold a significant position in the global trade volume of all three industries. Türkiye is known as one of the leading countries in the world in the door, glass, and window sectors. As RX Tüyap we are working tirelessly to consolidate this strong position and contribute to these industries' global goals. We have already started preparations for our next events on November 16-19. Our aim and belief are that we will close our fairs with record visitor numbers and a high trade volume."

Free Fair Tickets :

For those who want to experience the newest products, technologies, and services on-site, tickets for all three fairs are free of charge until August 16, 2024. It is possible to visit all three fairs with a single ticket obtained from the fairs'

websites at

1. eurasiadoorfair.com
2. eurasiawindowfair.com
3. eurasiaglassfair.com.



NGA Glass Conference Kicks Off in Isle of Palms, South Carolina

About 100 technical and advocacy leaders in glass are gathered in South Carolina this week for the NGA Glass Conference: Isle of Palms | Charleston. The event runs through Feb. 8, and includes meetings for the NGA Advocacy, Fabricating and Forming Committees.

Other highlights include a comprehensive look at new codes and standards, an update on U.S. Department of Energy Collaborations and a panel discussion on spandrel glass. The conference also includes a planning and practice session for the NGA's third annual Glass & Glazing

Advocacy Days, scheduled for May 14-15 in Washington, D.C.

Closing out the NGA Glass Conference will be a Laminating Workshop: Past, Present and Future of Laminated Glass Qualification. Recent changes to the Safety Glazing Certification Council laminated glass certification requirements will lead to an evolution in the nomenclature and shorthand used for describing and specifying laminated glass units. Attendees will gain a brief overview of laminated glass applications and how they relate to safety glazing.

HEGLA at Fensterbau Frontale: People in focus

At the Fensterbau Frontale trade fair in Nuremberg, people are the focus for HEGLA and HEGLA boraident. You will find HEGLA in Hall 3a, Booth 103.

The companies are presenting solutions at their booth that make work easier for employees, provide a high level of safety, and improve efficiency.

Transport glass and windows safely

To represent the options for converting a vehicle into a glass-industry vehicle, HEGLA is exhibiting a Renault Master. An exterior rack alone promises benefits: fitters can ergonomically set the glass, window or structural element down on the rack without having to enter the interior or lift the load accordingly. Anti-slip, solid rubber profiles protect the surfaces of the load and enable professional transport. The load is secured by height-adjustable slat bars that save time. If even more support is required, the

two lashing rails (standard equipment) provide greater security.

If additional rack positions are necessary for multiple orders, for example, HEGLA recommends a conversion with an interior rack with a folding horizontal support. If the load is particularly sensitive to damage, it will be protected against damage from stones and rain there. And when the loading position is no longer needed, the horizontal support can be folded upwards to free up the maximum width of the loading space. To make a good first impression on glass customers, Marc-Alexander Stachel from HEGLA Fahrzeugbau recommends a tool cabinet system: "Everything has its place in the system; the delivery van is tidy, and even alternating teams know that all materials are safely stowed away and easy to find."

Visit us in Hall 3A
at Stand 3A-103



FENSTERBAU
FRONTALE

19.-22.3.2024
NÜRNBERG, GERMANY



For Fensterbau Frontale, HEGLA is offering a limited edition: ready-to-ship Renault Masters equipped for the glass industry at a special price. And in line with the football event, an event rack that can be removed from the vehicle and, with the supplied holder, used as a mobile shooting goal is also on offer.



Robust, intuitive lifting technology for glass and windows

Despite the general progress, manual handling is still part of the everyday routine in glass companies. “To ensure a high level of safety, vacuum devices must have intuitive controls and be robust,” said Holger Brechtelsbauer from HEGLA in Kretzschau. “We cannot change the weight and material properties of glass, which is why we must create conditions that support human employees and provide them with the necessary protective mechanisms.” At Fensterbau Frontale, a pillar-guided device in the Isofix series that achieves high motion safety in all processes, thus relieving employees, will be exhibited. The individual suction devices are ejector-controlled and maintain the vacuum, even if not all positions are in use. If, despite the highest level of quality, low-maintenance technology and professional handling, the emergency situation of a pressure drop does occur, the devices are safeguarded such that enough time to set down the glass or window remains. Further, HEGLA is also showing the advanced devices in the Hubfix series, which feature pneumatic interlocking of rotational movement to simplify operation.



Profile diversity and direct access in long goods storage

Both profile diversity and the number of different customer requirements are growing. The compact storage system for long goods from HEGLA can help here in two ways: first, the individual types have a tidy storage space that provides direct access. Second, the system saves storage area, which in turn is available for either more profiles or other tasks. The long goods pallets are kept ready in space-saving cantilever arm shelves on rails, which are arranged next to each other without any gaps. A gap for handling does not open until a pallet needs to be removed or stored. “With this system, storage capacity increases by up to 50 percent,” explained Florian Laue from the HEGLA centre of excellence for long lengths. “It enables time-saving access to all material without re-stacking, and even makes front removal possible.”



With laser marking from HEGLA boraident, doors and windows are now digital! Once the high-resolution marking is applied to the profile, the profile can be clearly identified at any time. Via scan, employees can access production data, track properties or generate a re-order in production, in shipping, or at the construction site, for example. Depending on scanner integration into the production process, extensive integration that enables triggering processing steps, tracking them and more is possible. "A clear marking with a QR or data matrix code creates a permanent connection between the profile and digital information," said Dr Thomas Rainer from HEGLA boraident. "From writing the delivery slip via scan and acknowledging delivery on site, to documentation of who supplied the structural element for large-scale projects: many digital applications are possible."



Greater value creation with laser finishing to create bird protection glass and RF-transparent glass

The specialist from Halle/Saale has a second major theme at the trade fair. The company offers different systems and lines for laser finishing with which single panes or finished IGUs can be subsequently upgraded with an additional function. Thanks to coating transformation or printing, it is possible to create bird protection glass, RF-transparent glass or, for example, a heatable pane. "Our customers benefit from the option to finish standard products without retooling time for a batch size of one, and create more value in the process. The competition for customers and market share is heating up, and we have created a product benefit here that generates higher income and makes companies flexible," said Thomas Rainer.

"We look forward to Fensterbau Frontale and the gathering of the glass industry there," added Managing Director Bernhard Hötger of the HEGLA Group. "With our focus on the people in companies, we want to send an important signal and honour their work." The trade fair in Nuremberg is also a key place for exchanging information on trends, visions and the future of the glass industry.





Energy Efficient Insulated Windows with ENERGY STAR® 7.0 requirements

Energy Star, a trusted symbol for energy efficiency, extends its influence on windows, offering consumers a reliable benchmark for making environmentally conscious choices.

In the pursuit of sustainable and energy-efficient living, selecting the right windows for your home is crucial. Energy Star, a trusted symbol for energy efficiency, extends its influence on windows, offering consumers a reliable benchmark for making environmentally conscious choices. Therefore, it is important that companies follow the Energy Star requirements in their production to leverage energy efficient insulated windows.

Understanding Energy Star Rating :

Energy Star-rated windows are designed to meet energy efficiency guidelines set by the U.S. Environmental Protection

Agency (EPA). These guidelines consider factors such as U-factor, solar heat gain, and air leakage. By opting for windows with the Energy Star label, homeowners can significantly reduce energy consumption, lower utility bills, and decrease their carbon footprint.

Key Features of Energy Star Rated Insulating Windows

Enhanced Insulation: Energy Star-rated windows are equipped with advanced insulation technologies, such as low-emissivity (Low-E) coatings and multiple glazing layers. These features help in minimizing heat transfer, keeping homes cooler in the summer and warmer in the winter.

UV Protection : The windows are designed to block harmful ultraviolet (UV) rays, not only safeguarding your furniture

and flooring from fading but also contributing to a more comfortable indoor environment.

Reduced Air Leakage: Properly sealed Energy Star windows significantly reduce air leakage outside in, and inside out, preventing drafts and ensuring a more consistent indoor temperature. This feature enhances comfort while lowering the workload on heating and cooling systems.

Solar Heat Gain Control: Energy Star-rated windows are optimized to control solar heat gain, allowing natural light to enter while minimizing heat transfer. This balance ensures a well-lit and comfortable living space without excessive energy consumption.

How Does Insulating Gas Concentration Relate to Energy Star?

Thermal Insulation: The insulating gases, such as argon or krypton, are denser than air. When these gases are sealed between windowpanes, they reduce heat transfer through the window. This helps to improve the window's U-value, which is a measure of how well a window insulates. Lower U-values indicate better insulation.

Energy Star Requirements: Energy Star sets criteria for U-values that windows must meet to qualify for the label. The use of insulating gases is one of the factors considered in meeting these criteria. Windows with a lower U-value, achieved in part by insulating gases, are more likely to meet the Energy Star requirements.

Climate Zone Considerations: In different climate zones, the concentration of insulating gases might be adjusted to

optimize energy efficiency. For example, in colder climates, a higher concentration of insulating gas may be used to enhance thermal performance.

Comfort and Energy Savings: Windows with proper insulating gas concentrations contribute to a more comfortable indoor environment by minimizing heat loss in the winter and heat gain in the summer. This, in turn, can lead to energy savings as the heating and cooling systems have to work less to maintain a consistent indoor temperature.

READ SPARKLIKE DISTRIBUTOR GED INTEGRATED SOLUTION'S BLOG POST ENERGY STAR® 7.0 MAKING INTELLIGENT DESIGN DECISIONS

Conclusion

Investing in Energy Star-rated insulating windows is a proactive step toward a more energy-efficient and environmentally conscious building. When looking for Energy Star-rated windows, it's not only the U-value that matters but also the specific features of the window construction, including the type and concentration of insulating gases used. Manufacturers of Energy Star-rated windows provide details on the window specifications, including the presence and concentration of insulating gases. By prioritizing these windows, homeowners not only enjoy the immediate benefits of lower utility bills and increased comfort but also contribute to a greener and more sustainable future. Therefore, following the Energy Star requirements is crucial to make energy efficient insulated windows.

Saint-Gobain Hardware Solutions and SS Glass Industries

Organized a knowledge full meet regarding the future of Glass Hardware Solutions

A well-known, reputed, reputable and progressive firm of Kanjhawala, Delhi, S. S. Glass Industries, which has been engaged in the manufacturing of glass putty for the last 23 years, is moving on the path of progress.

The supply of glass putty manufactured by the said firm is going to North India. It is to be known that even though the trend of glass putty has reduced at present, 'Super Fix' and 'Royal' brand glass putty have become firmly established in their field of business on the basis of their quality. Nowadays, silicone has taken over glass putty to a great extent, but glass putty manufacturers in any country are based on their best grade is the result of quality and high level reputation. Putty is mostly used for fixing glass in steel, wooden windows and glazing.

M/s S.S. Glass Industries, During his business tenure, Mr. Dinesh Singh, 43 year old proprietor of Glass Industries, has created such a special place for himself in the glass putty industry on the basis of tireless hard work, true dedication towards work, sweet behavior and honesty that very few businessmen can do so. Are capable of. In human life, be it job or business, along with work, speech and behavior is also required. Shri Dinesh Singh was filled with all these qualities.

And due to these qualities, he is making every effort to take his business towards the pinnacle. The said firm, along with glass putty manufacturing, also deals in Saint-Gobain architectural hardware and acts as an authorized distributor only in NCR, and is also a major manufacturer of Conway mirrors (rear view). It earns huge amounts and supplies it all over the country as per the demand and also has a dealership in Delhi market for the sale of Alstone ACP products.





9866892986

SRI VENKATA JAYALAKSHMI GLASS WORKS



Mfg. of : Automobile Laminated Safety Glass

WHOLE SALE & RETAIL :- All Type of Automotive Glasses

- All Car Glasses
- All Bus Glasses
- Silicone Sealant
- Rubber Beedings
- All Toughened & Laminated Automotive Glass

Plot No. 271/1, 6th Lane, Autonagar, Vijayawada-7
E-mail : Kanakahrao@gmail.com

9 SUCCESSFUL YEARS



**FLAT AND BEND STABLE AND TROUBLE
FREE WORKING FURNACE
AT ARIHANT SAFETY BANGALORE**

**CUTTING LINE
JUMBO/HALF JUMBO**

SK-Hitech
8×14
8×12
9×16
10×16
10×20



S.K. HITECH GLASS MACHINES PVT. LTD.

Address : 51, Navyug Market, Ghaziabad-201001 (UP)

E-mail : saleskhg@mail.com, skghmachines@gmail.com, Web.: www.skghmachine.com

GURDIT SINGH : 98100 13942, 93100 13942, RAKHI : 9821400198

Hari



Dushvinder Kumar
M.: +91-98786-06495
Balvinder
M.: +91-98148-16495

HARI OM TRADERS

Authorised Dealers :



- Saint Gobain
- Modiguard Float Glass
- Float Glass
- Toughened Glass
- Asahi Float Glass
- All kind of Glass Work

Basti Adda Road, Near Bank of India, Jalandhar City (Punjab), India
Phone : +91-181-2403326, 2403256, 5001013
E-mail : balwinder0003@gmail.com

Kamal Aggarwal
Chhavi Aggarwal

OM SHANTI

+91-98140-26520
+91-99886-17411

S.K. GLASS COMPANY



Deals In : Complete Range of Architecture and Automobile Glasses

- Toughened Glass
- Security Glass
- Insulated Glass
- Automobile Glass
- Designer Glass
- Shower Enclosure
- Patch & Spider Fitting etc.

Chowk Dholewal, Ludhiana

aggarwal.chhavi@yahoo.com
 www.skglasscompany.com



Chandan Shadija
Rohit Shadija
+91-9589814444

INDUS GROUP

(FORMALLY KHUSHBOO ENTERPRISES)

Add.: Near Yatayat Thana, Harshit Vihar, Urkura, Raipur (Chhattisgarh)
E-mail : indusglassco@gmail.com



Importer of :

- 3 mm Aluminum Float Mirror
- 4 mm to 19 mm Extra Clear Float Glass
- Extra Clear Lacquered Glass
- Colored Mirror : Brown, Purple, Pink, Blue, Golden
- Fluted Glass / Acid Etched Glass
- Extra Clear Mirror (3 mm to 8 mm)
- 1.8 mm to 6 mm Aluminum Coated Mirror
- 1.8 mm Clear Sheet Glass

Sister Concern

Janta Photo Frame Store

Near Gurunanak Chowk, M.G. Road, Raipur (C.G.),

Phone : +91-9301099790

E-mail : jpf3693@gmail.com



An ISO 9001:2015 Certified Company

NAITRI ENTERPRISE

Manufacturer of Glass Etching Sticker Roll.
Deals in Glass Machine Accessories & Glass Machineries.

Authorised Agent for India.



NAITRI ENTERPRISE
107, Shiv Ashish Ind. Soc.-1, Nr. Volks Wagen Show Room,
New Bamroli Road, Udhna, Surat - 394 210 (Guj.) INDIA.
Mob. : +91-98795 24439, +91-99090 95004, +91-99254 14822
www.naitriglasstools.com | E-mail : info@naitriglasstools.com



Event CALENDAR

Notice : In case the organizer changes the dated and place of the exhibition then the G.H.A. Info will not be responsible for it.



Where Glass Technology Comes Alive

Fiera Milano Rho
ITALY
www.vitrum-milano.com

5 - 8 September
2023



20th International Trade Fair on Glass production, Processing, Technology & Products

Bombay Exhibition Centre (NESCO), Mumbai
INDIA
www.zakglasstech.com

23-26 November
2023



INTERNATIONAL TRADE FAIR FOR GLASS PRODUCTION • PROCESSING • PRODUCTS

Discover the unlimited variety of possibilities of glass at glasstec experience the future of glass up close with the very latest solutions from technology, production and glass applications.

Dusseldorf
GERMANY
www.glasstec-online.com

22-25 October
2024



International Exhibition for Flat Glass Processing and Products
Doors, Windows & Facade

Bombay Exhibition Centre, Mumbai
INDIA
www.mirstakia-expo.ru/en/

14 - 16 September
2023



The Windows, Doors & Facades and Gulf Glass events provide an unmatched platform for the windows, doors, facades and glass industry to secure new business across the middle East, africa, and south asia.

Dubai World Trade Centre
DUBAI
www.windowsdoorsandfacadeevent.com

4-7 December
2023



India's leading Design/Architecture Building & Construction Expo.

Bengaluru International Exhibition Center, Bengaluru

Pragati Maidan, New Delhi
INDIA
www.darcbuild.com

3-5 May
2024
Bengaluru

2-4 Aug.
2024
New Delhi



The Glassman event brings together glassmakers with leading technology suppliers. The two day show will include a conference that will focus on the latest trends, Issues and Opportunities in the glassmaking industry.

Songdo Convensia, Seoul
SOUTH KOREA
www.glassmanevents.com

20-21 September
2023



The Trade Show, Window, Door, Facade.

Nuremberg
GERMANY
www.frontale.de/en

19-22 March
2024



CHINA
GLASS 2024

Shanghai
New International Expo Centre

25-28
APRIL

Rajeev Gera

M. : 9329109448
6260855757

Ram Shyam Automotive Glass House



OPEL



To be Continue....

Auth Dealer :



Toughened Glass

Laminated Glass

Rubber Chanel

Manufactured of RSGH. Brand Laminated Safety Glass

Dealer :



Sister Concern :

RAM SHYAM AUTOMOTIVE GLASS HOUSE

4/24, 4/25, MG Market, Bhilai (C.G.)

Plot No. 20, Kedia Business Park, Bhilai Road, Tatibandh (Raipur)

E-mail : ramshyamrpr@yahoo.com

SAMRAT GLASS HOUSE

- TOUGHENED GLASS
- FITTING JOB
- BATHROOMS
- RAILINGS



- LED MIRROR
- STANDING MIRROR
- COLORED MIRROR
- FLUTED GLASS

- SPIDER FITTING
- MIRROR CLADDING
- LACQUERED GLASS
- BACK LIGHT GLASS

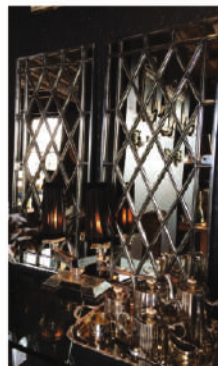

SANJEEV JAIN - 9417036173

SANKET JAIN - 7589070972



B-XVIII, 2993, JAWAHAR NAGAR, LUDHIANA



Padmavati Glass Company

Dinesh Kumar Jain
Call : +91-9395550153
Bharat Jain
Call : +91-6281073358

Authorised Stockist :



5-3-481, Old Topkhana Road, Opp., Osmangunj, Hyd-12 (T.S.)
Phone : 66569015 (O), 24612337
E-mail : pgc_hyd@yahoo.co.in

D.L. Glass Agencies

Deals in : All kinds of Building Glass
(Toughened & Laminated Safety Glass)

PRANAV SINGH

Call : +91-9826156986
0771-4023599

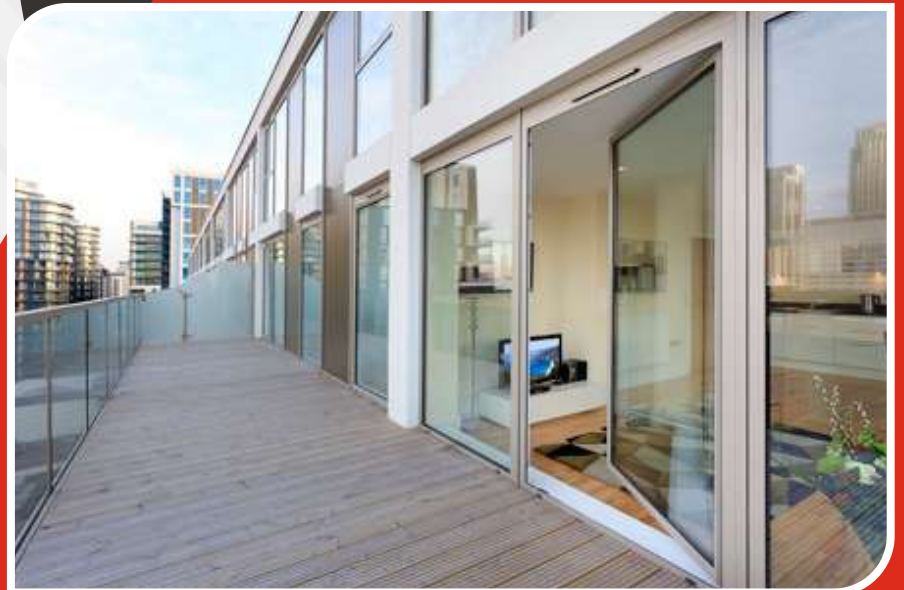

Authorised Dealer :



Sister concern :

SBR GLASS SOLUTIONS

Shop No. 131-32, Samta Shopping Arcade, Main Road, Samta Colony, Above HDFC Bank ATM, Raipur (C.G.)

E-mail : pranav267@gmail.com, dl.glass.agencies@gmail.com

ATLAS™ PRECISION GLASS CUTTING TOOLS

Glass Cutter



Neno Plastic

Glass Cutter



Aluminium Delux Golden Handle

Glass Cutter



Aluminium Delux White

Glass Cutter



Aluminium Delux Silver Handle

Glass Cutter



Standard Plastic

Glass Cutter



Plastic Haldle

Glass Cutter



Wooden Handle

Spare Vacuum Base



Vaccum Base

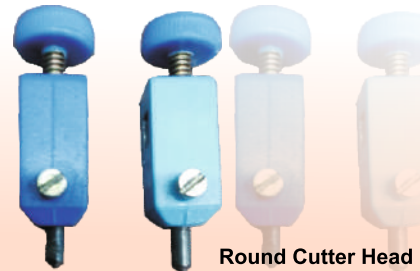

Round Cutter Head

Diamond Head pcs.



Round Cutter Pin

Heads for 1.3 mm Glass



Round Cutters

Distributors for Delhi: **DHINGRA POSTERS GALLERY (P) LTD.**

Cell: +91-9818072100, +91-9810011666

Manufactured by :

ATLAS™
P R O D U C T S

220, Creative Industrial Estate, Sunder Nagar, Kalina, Santacruz (E),
Mumbai-400098, Maharashtra, INDIA • Ph: 022-26671882

R. M. SARDESAI: +91-9821881655

E-mail: atlasproducts@gmail.com • Website: www.atlasproducts.net



Goutam

GLASS INCORPORATION



Deals in : Toughened Glass • Fabric Laminated Glass • Glass Railing System
• Slim Partition System • Aluminium Wardrobe Profile Etc.

5-3536, Old Topkhana Road, Osmangunj, Hyderabad-500012(T.S.)

Visit us at : www.goutamglass.com, Mob.: +91-4024603524

Tel. Fax : +91-4066745133, E-mail : goutamglass@gmail.com, info@goutamglass.com

Manish Jain +91-9866355133

JS Glass & Plywood

P.D.V.N. Raju (Nani)
8522852260, 2566727 (O)
Sharon (Chanti)
9059347044



Authorised Distributor :



Specialist in :

Glass Etching | Acid Work | Air Burshing | Tuff Glass | Bend Glass
Stain Glass | Beviling | Edge Polishing | Glass Furniture | V. Groove
& All tyes of Aluminium Works

JS Glass & Plywood

44-38-12/31, Srinivasa Nagar, 80 Feet Road,
Akkayyapalem, Visakhapatnam-530016

E-mail : jsglassplywood@gmail.com | Website : www.jsglassconcepts.com



JS Glass & Designs

D.No. : 45-40-65, Main road, Beside Bezawada Home Foods
Akkayyapalem, Near Highway Junction, Visakhapatnam



A. Waheed Khan
(MD)
Salman Khan
+91-7032308416



- Toughened Glass
- Insulated Glass
- Shower Cubicals
- Glass Furniture

Remax Glass Works

Office : 5-3-590, Malakunta, Gosha Mahal Road,
Hyderabad-12, Telangana, INDIA

Mfg. Unit : Plot No. 3/8 B, Sy. No.148

Automotive Park, APIIC Ltd, Kallakal (V),
Toopran (M), Medak(D)-502336

E-Mail : khanawa2007@yahoo.com

Charanjeet Singh
(M) 098554-41393
(S) 0161-2447534
Simranjit Singh
098144-84854



Diamond Glass House

Special Arrangement for : Tuffened Glass Fittings

Exclusive Designs of Fusion Glass Textures Glass Air Brushing Deep Etching, Stain Glass & Beveled Glass etc.

Auth. Retailer :



Kailash Cinema Road, Near Domoria Pull, Civil Lines Ludhiana-141001
Email : singh86simranjeet@gmail.com

Mr. Varun Sethi

M.: 9440139142
9502228582

VARUN

GLASS AGENCIES

Whole Sale & Retail Dealers in :

All Kinds of Automobile Glasses, Rubber Bendings



Stockist for : SIK A India (P) Ltd., Saint Gobain Sekurit.  E.C.I.

D.No. 55-5-37, Plot No. 27, 4th, Lane, Autonagar, Vijayawada-520 007
E-mail : varunglassagencies@gmail.com

Vinod Das
Mob. : +91-9216859583

Processors all types of Exclusive Decorative Glass in Punjab



Exclusive Designs of Etching, Deep Etching, Stain Glass Paintings, Air Brushing, Fusion Glass, Texture Glass & Beveled Glass

Vinod

Glass House



We Also Undertake Outdoor Glass Fitting

69- Lajpat Nagar, Opp. Railway Line, Ludhiana

The New Generation Toughened Plant in Meerut



GLASS 'N' GLASS



- Toughened Glass
- Heat Strengthened Glass
- Insulating Glass
- Laminated Glass
- Decorative Glass
- Bend Glass

MOHD. IRFAN
Call us : +91-9837246871

For any sales enquiry :
+91-8979011114/8, +91-8979022229
Factory : 0121-2704890



GLASS 'N' GLASS

27, Bhawani Nagar, Hapur Road, Meerut City-250002 (UP) INDIA
E-mail : glassnglass2008@yahoo.com, gngtuff@gmail.com



Toughened Glass | Laminated Glass | Insulated Glass | Beveling | Stain Glass
 Etching-Bend Glass | Shower Cubicles | Glass Furniture | Decorate Mirror
 Lacquered Glass | Patch Fitting | Spider Fitting | All type of Glass Fabrication

Authorised Dealer :



ARSHI IBRAHIM & SONS

GLASS AND HARDWARE

Add.: 13 & 21, Bhairav Arcade, Sahu Complex, Pillar No. 16, Exhibition Road, Patna-800001

Mob.: +91-99553 05333, +91-99553 73222

E-mail : arshiibrahimsons987@gmail.com

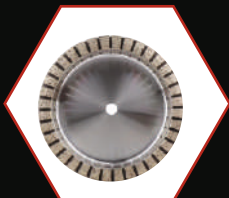

Glass Straight Line Edging Machine



Glass Straight Line Beveling Machine

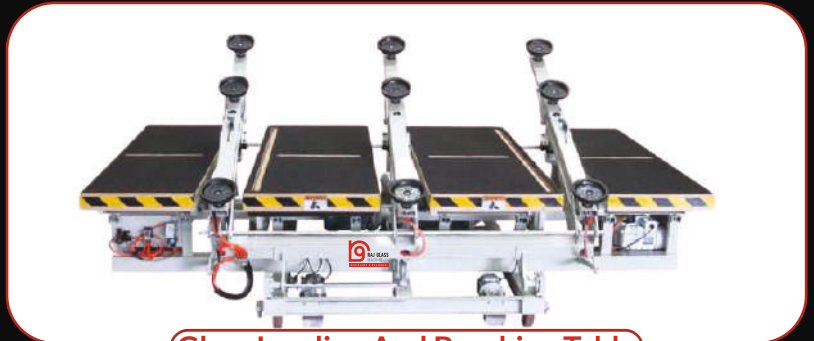

Glass Loading And Breaking Table



Glass Corner Grinding Machine



Irregular Glass Shape Machine

**www.rajmarketing.co.in
www.rajglassmachine.com
www.glassmachinetools.com**



Glass Double Edging Machine



Glass Washing Machine



Vertical Glass Sand Blasting Machine



Horizontal Glass Sand Blasting Machine



Glass Drilling Machine (Automatic)



CNC Multi Function Glass Cutting Table

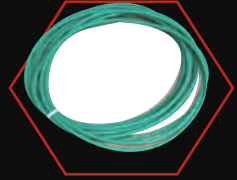

Glass Cutting Line



Ray

MARKETING

Darshan Jain
9320223355

Virag Jain
7222866661

Dilip Jain
9322030222

B/1005, Venkatesh Shanti CHS Ltd,
Balaji Complex, 150 Feet Road, Bhayandar (W)
Thane - 401101 (Maharashtra)

All Kinds Of Glass Machinery & Spare Parts Under One Roof

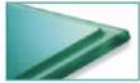

6 Spindles Glass Round Edging Machine



Glass Straight Line Beveling Machine with Automatic Lubricating System



Available in 9 Spindles, 10 Spindles & 11 Spindles

Double Glass Drilling Machine (Heavy Duty Model)

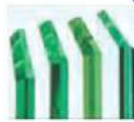

Glass Straight Line Edging Machine with 45° with Automatic Lubricating System



Available in 9 Spindles, 10 Spindles & 11 Spindles

Glass Vacuum EVA Laminated Machine with Five Layers with Low Power Consumption (Available in LPG Model also)



EVA Film



Horizontal Glass Washing & Drying Machine



Special Model for Low-e Glass also available

Manufacturers of

- ☆ BI Glass Tempering Furnace ☆ BI Glass Lamination Line ☆ BI Glass Insulating Line
- ☆ BI Glass Cutting Line ☆ BI Glass Washing Machine ☆ BI Glass Beveling Machine
- ☆ BI Glass Grinding Machine ☆ BI Glass Drill Machine ☆ BI Glass Shape Machine
- ☆ BI OG Edging Machine ☆ BI Sand Blasting Machine ☆ BI Belt Grinder
- ☆ BI Glass Diamond Wheels ☆ BI Polishing Wheels ☆ BI Resin Wheels
- ☆ BI Glass Drill Bits ☆ BI Water Jet Cutting Machine

Made in India Glass Tempering Furnace



Cutting Line with (Loader, Cutting Table & Breaking Table)



Diamond Wheels, Polishing Wheels & Resin Wheels



Drill Bits



Glass Bending Furnace
with 90° Bend, with Better Efficiency
LPG Model also Available



BHAMBRA INTERNATIONAL

111/G, DLF Industrial Area, Phase-1, Faridabad-121004 (Hr.) INDIA
Ph.: +91-95129-2250673, 2250914 • Cell: 9810020824, 9999130078

E-mail: bhambrainternational01@gmail.com
Website: www.bhambrainternational.com



Biggest Spider Works in A.P. Completed by SKML GLASS

- ◆ VUDA CHILDREN THEATER
- ◆ GITAM MEDICAL COLLEGE
- ◆ RAMA TALKIES

Specialist in :

- | | |
|------------------------|--|
| ● Original Stain Glass | ● Spider Fitting |
| ● Automobile Glass | ● Etching, Beveling |
| ● Glazing, Toughened | ● All type of Value Addition Glass Works |
| ● Patch Fitting | |

Auth. Distributor of : South Glass Pvt. Ltd.



S.K.M.L. GLASS HOUSE

#32-1-200/4, Srikanya Lodge Complex, Bowdara Road, Opp. SRMT, VISAKHAPATNAM-530 004

E-mail : skmlglasshouse@gmail.com

Branch Off. : Shop No. 3, Babu shopping Complex, Old Gajuwaka, Vishakhapatnam-26

Mr. Srinivas +91-9848582707 L. Anand Raj +91-9866055703

Pavan Glass Gallery

Your Imagination is our creation

Chetan Patel
+91-9098952416
Hitesh Patel
+91-9752524416



Deals In :

- All kind of clear & designer float glass
- Toughened Glass
- Insulated Glass
- Bevelled Glass
- Textured Glass
- Laminated Glass
- Glass Hardware
- Edge Polish
- Shower Cubicles
- Acid Work Etc.



Head Office : Opp. Patidar Bhawan, Timber Market, Fafadih, Raipur-492001 (C.G.)
E-mail : pavanglassgallery1616@gmail.com
Mobile : +91-9098952416, +91-9752524416

AGGARWAL GLASS HOUSE

**PUNJAB's Leading One
Wholesale Business House**

Authorised Wholesale Dealers & Stockist



Gujrat Guardian Ltd.



**Gold Plus Glass
Industries Ltd.**



Asahi India Glass Ltd.



**BHARAT GLASS
TUBE LIMITED**

DISTRIBUTOR :



- Glass Beveling
- Glass Polishing
- Toughened Glass
- Lacquered Glass
- Clear Glass & Mirror (all size available)
- All type of architectural glass

**All Type of Architectural Glass Works
Under One Roof**

Firozpur Road, Near Umbera Homez, Vill. Gahaur, Ludhiana (Punjab), INDIA

E-mail : varun.agg23@gmail.com

Varun Aggarwal Mob. : +91-98150 16300

Mannat

ALWAYS SPRAY ON TIN SIDE OF GLASS

BACK PAINT SYSTEM

Two component solvent based opaque coating. It has excellent scratch resistant adhesion. Available in more than 60 shades. Pearl & Fluorescent colours also available. Only PU Thinner to be used for dilution.

Available in :

- OPAQUE • TRANSPARENT • METALLIC
- FLUORESCENT • PEARL EFFECT

Supreme



PU CLEAR

For Glass and Ceramic

Two pack coating with a ratio of 4 : 1. Used as a pre-coat of digital printing on glass and ceramic



MIRROR EFFECT COATING

Transform Clear Glass closest to Mirror
Ideal for Glass Designing

Recommended for designing
Apply 3 coats with spray gun at low pressure
Black back paint after 5 hours of coating



Frosting Effect Coating

SEMI-TRANSPARENT FINISH

Creates a frosted glass finish with direct application on Glass

Two pack solvent based system to replace acid frosting. Tinter can be added to get different colour.



White+

Coating with Extra Whiteness

To achieve more whiteness on normal glass



UV Glass Adhesive

Commercial for small Glass to Glass

- SH 110 - For sticking Glass to Glass
- SH 128 - For sticking Glass to Metal
- SH 133 - Edge to surface of Glass
- Gel - Thicker Glue



AIR BRUSH GLASS COLOURS

Available in one pack base which should be brushed without adding any type of thinner to get sand blasting effect for colours Gold and Silver.

1 part ratio and 2 part base tinter.
Ready colour for Sand Blasted effect.



PRIMER

Fast Drying Precoat

Can be applied with cloth.
Thinnest coating recommended.

TOP COAT

UV Coating for protecting Digital Printing on Ceramic



ENHANCER

VALUE ADDED PRODUCTS ON GLASS

1308, Sai Niketan, 345 Mount Road, Near GST Tax Office, Mazgaon, Mumbai 400 010. Cell : 93212 90705
mannatcoating@gmail.com • www.mannatcoating.com

SK Glass Machines (India) Pvt. Ltd.

Pre Processing Machines and Solution

Glass Straight Line Edging Machine (SKE-Series)
(SKE-Series)



SKWJ-3112
Waterjet Cutting Machine

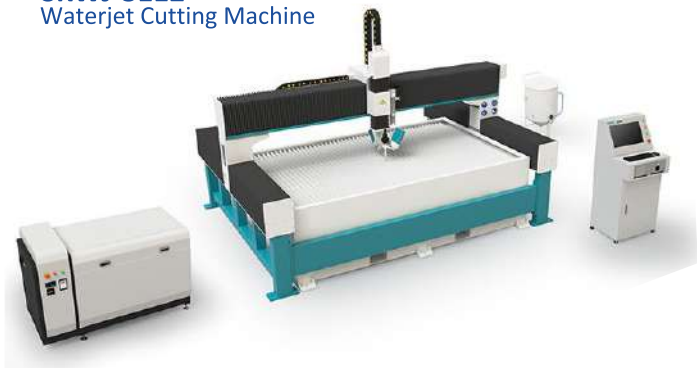

SKHSB-2200
Horizontal Sand Blasting Machine



SKD-1508 PLC
X & Y Automatic Glass Drilling Machine



Glass Straight Line Beveling Machine
(SKB-Series)



Horizontal Glass Double Drilling Machine
(SKD-Series)



LOW E PLC
Glass Washing Machine



Phoenix-2615
Horizontal CNC Work Center Machine



Product Highlights :

- Vertical Glass Straight Line Edging Machine
- Vertical Glass Straight Line Beveling Machine
- Horizontal Glass Washing Machine
- Horizontal Glass Drilling Machine
- Waterjet Cutting Machine
- Horizontal/Vertical Glass Sand Blasting Machine
- Horizontal Glass CNC Work Center Machine

HIGH PRESSURE TOP CONVECTION FURNACE FOR TRIPLE SILVER SOFT COATED GLASS LOW E = 0.018

MORE THAN 120 FURNACES INSTALLED WORLDWIDE



Horizontal Top Forced Jet Convection Glass Tempering Furnace



SKTFC-Top Forced Convection Machine

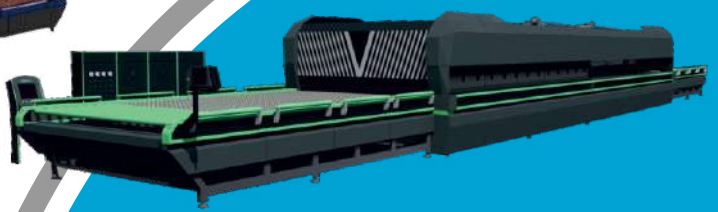

5th Generation High Pressure Top Forced Convective Furnace

- Capability to Produce Triple Silver Coated Low-e Glass (e=0.01)
 - Unique & Intelligent Siemens Control Heating System.
 - Special Forced Convection Heating Profile Technology.
 - PLC and VFD by Siemens Germany.
- Both Flat and Bend option Available



Model No: 8x14 Ft
Model No: 9x14 Ft
Model No: 9x16 Ft
Model No: 10x14 Ft



Siamars S7 PLC



Super Low-E Glass (0.01)



Intelligent Control

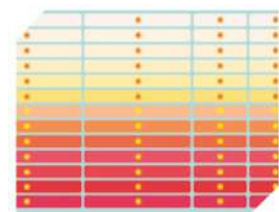

Fine Heating Matrix



Faster Production



S.K. GLASS MACHINES (INDIA) PVT. LTD.
 Factory
 D-9, Meerut Road, Industrial Area,
 Ghaziabad, Uttar Pradesh-201001 INDIA

Domestic Sales : +91-9310013944
 International Sales : +91-9873926105
 E-mail : sales@skglassmachines@gmail.com
 www.skglassmachines.com



SK Glass Machines (India) Pvt. Ltd.

EVA Film for Laminated Glass

Your Domestic Source for Glass Interlayer and Glass Machinery

Autoclave Free Glass Laminating Machine

EVA | PVB | SGP | PDLC | FILM FOR INTERIOR & EXTERIOR LAMINATED GLASS



Available Sizes:

6X12 Ft

7X12 Ft

8X12 Ft



Forced Convection Heating Technology

THE NEW LEVEL OF EVOLUTION

EVA Roll

Color EVA | PVB Film

Teflon Roll

Decor Laminated Glass

Switchable PDLC Film Roll

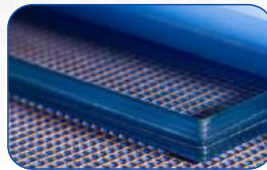

Specifications:

Thickness (mm)	0.25 / 0.38 / 0.76 / 1.52 mm
Width (mm)	1830 / 2000 / 2250 / 2440 / 2500 mm
Roll/ Length (mtr)	50 / 100 / 150 M
EVA Colours	Indoor Clear, Extra Clear Outdoor, Super Transparent, Milky White, Frosted, Dark Green, Olive Green, Light Green, Yellow, Dark Blue, MEDITERRANEAN Blue, Light Blue, Orange, Euro Bronze, Dark Brown, Black & Light Brown etc.



S. K. GLASS MACHINES (INDIA) PVT. LTD.

D-9 Meerut Road Industrial Area, Ghaziabad, UP
+91 9310047273, +91 81300 92790

sales.skchevron@gmail.com, sales@skglassmachines.com



Whatsapp Us:
+91 9310047273

Metal Mesh | Fabric | Inserts | PET Film | PDLC | EVA | PVB | Dichroic | PVC Mesh | SPD | LCD EVA | Smart Blinds | SPG | LED Liquid Film

PRINCE POLO
Design... Style... Quality...

DECORATIVE T PROFILE
ONLY ₹250

FIRST TIME IN THE WORLD
MATERIAL: STAINLESS STEEL
HEAVY QUALITY BY
THICKNESS: 0.8
LENGTH: 3050MM

MINIMUM ORDER QUANTITY 500 PCS

T PROFILE, U PROFILE, L CORNER

SIZE AVAILABLE: 6MM, 8MM, 10MM, 12MM, 15MM, 20MM, 25MM

RATE PLUS GST: 1 FEET FOR ₹25, 10 FEET FOR ₹250

👍👍 ALL SIZES PRICE ARE SAME 👍👍

PAYMENT ALWAYS IN ADVANCE

FINISH
GOLD MIRROR
ROSE GOLD MIRROR
SILVER MIRROR
BLACK MIRROR

Mr. Paresh Shah
Address: 61 kika street, (gulawadi), ground floor, mumbai-400 004
98200 57658 www.princepolo.in

PRINCE POLO
Design... Style... Quality...
Architecture Hardware Fittings

Mumbai



Payment Always in Advance

PDH-022 DOOR HOLDER
Finish: SS, AB,
₹ 103 + G.S.T
Weight: 85 grams, (120 PCS CARTOON)
Paresh Shah (Proprietor):-
98200 57658

PRINCE POLO
Design... Style... Quality...

PAYMENT ALWAYS IN ADVANCE

SRG-009 SELF OPEN DOOR CATCHER
FINISH: GREY



RATE ONLY RS 22/- PLUS FULL GST
IMPORTED
CARTOON PACKING 1,000 PCS.
MINIMUM ORDER 1,000 PCS
INDIA'S MOST REASONABLE RATES !!

Mr. Paresh Shah
Address: 61 kika street, (gulawadi), ground floor, mumbai-400 004
98200 57658 www.princepolo.in

PRINCE POLO
Design... Style... Quality...
Architecture Hardware Fittings

Mumbai



Payment Always in Advance

PDH-060 DOOR HOLDER
Finish: SS
₹ 75 + G.S.T
Weight: 104 grams, (120 PCS CARTOON)
Paresh Shah (Proprietor):-
98200 57658

PRINCE POLO
Design... Style... Quality...

GERMANY WOOD

PAYMENT ALWAYS IN ADVANCE

Hang in Style,
UNLEASH THE ELEGANCE



FINISH NET RATE

4-HOOK	140/-
6-HOOK	210/-
8-HOOK	280/-

Mr. Paresh Shah
Address: 61 kika street, (gulawadi), ground floor, mumbai-400 004
98200 57658 www.princepolo.in

PRINCE POLO
Design... Style... Quality...
Architecture Hardware Fittings

Mumbai



Payment Always in Advance

PDH-056 DOOR HOLDER
Finish: Glossy SS, AB, Black Matt:
₹ 135 + G.S.T
Finish: Rose Gold PVD, Gold PVD:
₹ 165 + G.S.T
Weight: 199 grams, (120 PCS CARTOON)
Paresh Shah (Proprietor):-
98200 57658

PRINCE POLO
Design... Style... Quality...
Architecture Hardware Fittings

Mumbai



Payment Always in Advance

PDH-054 DOOR HOLDER
Finish: SS Matt, Black Matt
ONLY ₹ 120 + G.S.T
Weight: 196 grams, (120 PCS CARTOON)
Paresh Shah (Proprietor):-
98200 57658

PRINCE POLO
Design... Style... Quality...

VERTICAL
TOP BOTTOM
DIVIDER
FRAME SWING FRAME
PUSH FRAME SWING FRAME
LENCLOSE CAP



4005

SUPER SLIM PROFILE IMPORTED WITH 25 MICRON PLATING !!

IMPORTED ONLY 100% SAME AS ARISTO , OUR PRICE MOST REASONABLE

Mr. Paresh Shah
Address: 61 kika street, (gulawadi), ground floor, mumbai-400 004
98200 57658 www.princepolo.in

PRINCE POLO
Design... Style... Quality...

TELESCOPIC IMPORTED



WARRANTY LIFETIME

4.50 & 6.50
INCH 55 GRAM & INCH 072 GRAM

FOR ANDAMAN & NICOBAR ISLAND, NAGALAND, JAMMU AND KASHMIR, MIZORAM, MEGHALAYA, TRIPURA, ARUNACHAL PRADESH

Mr. Paresh Shah
Address: 61 kika street, (gulawadi), ground floor, mumbai-400 004
98200 57658 www.princepolo.in

PRINCE POLO
Design... Style... Quality...

25 MICRO PLATING QUALITY



4507

VERTICAL DIVIDER HORIZONTAL INTERLOCK STICK

4507

- Fast moving in market
- Can make swing/sliding door
- Use vertical connector
- Easy installation

IMPORTED ONLY 100% SAME AS ARISTO, OUR PRICE MOST REASONABLE

Mr. Paresh Shah
Address: 61 kika street, (gulawadi), ground floor, mumbai-400 004
98200 57658 www.princepolo.in

PRINCE POLO
Design... Style... Quality...

Aluminium Profile Glass Shutter

IMPORTED



Elevate
Your space with precision
Hardware Excellence

FEATURES
Resistant against corrosion
Flawless finish
High strength

RATE ONLY RS 425/- PER KGS

- RATE + PLUS 18% FULL GST
- FULL PAYMENT ADVANCE
- READY STOCK TO DELIVER

Mr. Paresh Shah
Address: 61 kika street, (gulawadi), ground floor, mumbai-400 004
98200 57658 www.princepolo.in

POLO

HARDWARE COLLECTION (MUMBAI)

MR. PARESH K. SHAH

+91 9820057658
+91 9320057658

E-MAIL : sales@princepolo.in
Website : www.princepolo.in

WE ARE MANUFACTURERS OF

- **FLAT TEMPERING PLANT**
- **BEND TEMPERING PLANT**
- **FLAT AND BEND TEMPERING PLANT COMBINED**
- **HEAT SOAK / AUTOMATIC LOADERS FOR CUTTING MACHINES**

**FOR CLEAR TINTED REFLECTIVE & SOFT COATED GLASS KT, ST, SKN
(DOUBLE SILVER GLASS) TRIPLE SILVER GLASS (SOFT LOW-E)
FLAT & BEND GLASS TEMPERING FURNACE**



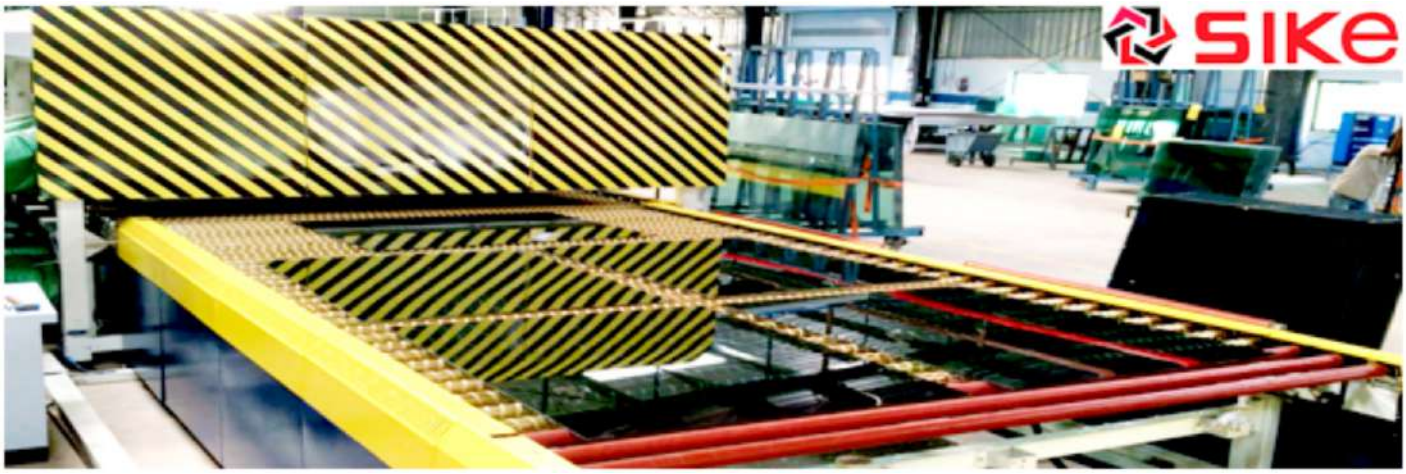

- 3.2 CAR SIDE GLASS (OEM QUALITY)
- VOLVO SIDE BUS GLASS
- ARCHITECTURAL GLASS

- COOK TOP GLASS
- 2 MM – 4MM SOLAR GLASS
- BEND GLASS FOR BUILDING

AVAILABLE IN INR ON GST PRICE

LOCAL SERVICE & LOCAL WARRENTTEE (IN INDIA)

OUR VALUED CUSTOMERS

- ⇒ JAY KHODIYAR, AHMEDABAD
- ⇒ FUTURE TUFF, AHMEDABAD
- ⇒ KRISHNA TOUGH, AHMEDABAD
- ⇒ BIG POWER TOUGH, AHMEDABAD
- ⇒ TUFF GLASS, INDORE
- ⇒ R & B GLASS, RAJKOT
- ⇒ TPRS ENTERPRISES, PONDYCHERRY
- ⇒ TPRS ENTERPRISES, DHARWAD
- ⇒ ARIHANT SAFETY, BANGALORE
- ⇒ MARUTI INDUSTRIES, PUNE

- ⇒ SABAQAH ZUJAJ ALZUJAJ EST, RIYADH
- ⇒ J K TOUGH , JALLANDHAR
- ⇒ SWASTIK GLASS, SONEPAT (EX-GOLD PLUS)
- ⇒ AMAFHH GLASS , MUMBAI
- ⇒ INFINITY GLASS INDUSTRIES, FARIDABAD
- ⇒ AMIT GLASS PVT LTD , JAIPUR
- ⇒ RAMDEV INTERPRISES, MUMBAI
- ⇒ MICO SAFE, MEERUT
- ⇒ SOLARIO TUFF'N GLASS PVT LTD, SONEPAT
- ⇒ AAIMAA GLASS CORP, HYDERABAD & MANY MORE



SIKE CHINA / S K GLASS INDIA

Email: sales@siketemp.com, marketing@siketemp.com Web.: www.siketemp.com/ www.skglassmachines.com

China: +0086-189 24899 177 / India +91-9310013944, 9821400198

GLASS AUTOMATIC LOADERS JUMBO n HALF JUMBO



Double Edger Loader



Multi Functional Manual Cutting Table with Air Cushion & Breaking Bars



Glass Automatic Loader



Glass Automatic Loader



Break Out Table



Break Out Table with Tilting Arms



Glass Automatic Loader

- ◆ MORE THAN 450 MACHINES WORKING IN WORLD WIDE
- ◆ LOCAL SERVICE ◆ *FREE INSTALLATION IN INDIA ◆ 3 YEARS OPEN WARRANTEE
- ◆ AVAILABLE IN INR/ IN GST PRICE ◆ READY AVAILABLE

CAN MATCH WITH ANY INTERNATIONAL BRAND OF GLASS CUTTING MACHINE

OUR VALUED CUSTOMERS

- | | |
|------------------------------|---------------------------------|
| ↻ GSC GLASS LTD | ↻ JAIN GLASS SOLUTION, SURAT |
| ↻ TPRS ENTERPRISES PVT LTD | ↻ GEETA GLASS, INDORE |
| ↻ RUBINE GLASS PVT LTD | ↻ N. N. SAFETY, HYDERABAD |
| ↻ R & B GLASS, RAJKOT | ↻ MANCHU TOUGH, CHENNAI |
| ↻ PITRUKRUPA GLASS, HYDRABAD | ↻ NANDI TUFF, HYDERABAD |
| ↻ JIVAN INDUSTRIES, RAIPUR | ↻ HYDERABAD SAFETY, HYDERABAD |
| ↻ AURUM SAFETY, BAHADURGARH | ↻ JAY KHODIYAR, AHMEDABAD |
| ↻ KRISHNA TUFF, AHMEDABAD | ↻ OLUMPUS, LUCKNOW |
| ↻ HARDWYN GLASS, DELHI | ↻ TUFF GLASS, INDORE |
| ↻ ASAHI INDIA GLASS LTD | ↻ AAIMAA GLASS CORP, HYDERABAD |
| ↻ WELL TUFF, DAMAN | ↻ J K TOUGH, JALLANDHAR |
| | ↻ ARIHANT BANGALORE & MANY MORE |



SIKE CHINA / S K GLASS INDIA

Email: sales@sikeloaders.com, marketing@siketemp.com Web.: www.sikeloaders.com/ www.skglassmachines.com

China: +0086-189 24899 177/ India +91-9310013944, 9821400198

ROLLS[®] HARDWARE

BELIEVE IN QUALITY

- Floor Spring
- Glass Connector
- Shower Knobs
- PVC Seal
- Wooden Sliding Fittings
- Glass Sliding Fitting
- Pipe Fittings
- Glass Door Handle
- Patch Fittings
- Glass Door Locks
- Shower Handle
- Glass Suction Lifter
- Glass Sliding Handle
- Shower Hinges
- Spider Fitting

Architectural Glass Fittings



Rolls Hardware LLP

Nirmal Avior Bldg, Upper Ground Floor, Shop No. 10,
Next to Deep Mandir Theatre, LBS Road, Mulund West, Mumbai-80
Phone : 022-49719300
Mobile : +91-9820572241 (Rajesh), +91-9819059496 (Bind Lal)
E-mail : rollshardware@gmail.com, salesrollshardware@gmail.com
web : www.rollshardware.com

Dealership Enquiry Solicited



K.G. & SONS
Float and Architectural Glass

S.K. Bansal
Sushil Goyal
+91-99150 30981

DORMA XL-C®



Auth. Dealer



Sister Concern
K.G. Bansal & Sons

DORMA XL-C®

SCO 846, Kalka Road, Manimajra, Chandigarh
Phone : +91-1722734482, 1722732248, 1725045482
E-mail : kgandsons.chd@gmail.com



DZM9
GLASS EDGING MACHINE



DSM20
GLASS DOUBLE EDGING LINE



DK3019
GLASS GROOVING MACHINE



Company Airscape



DEWAY MACHINERY CO.,LTD

Add: Longshi Industrial Park, Wu Gui Shan, Zhongshan, Guangdong, China
Post Code : 528458 Tel : +86-760-88785278 Fax : +86-760-88785161
<http://www.zsdeway.com> E-mail: sales@zsdeway.com

Contact Person :

Mr. Lee Email: lee@zsdeway.com

Tel: +86-13925346028 wechat: leevinglee

Ms. Jenny Email: jennyzhong@zsdeway.com

Tel: +86-18028338683 wechat: zh18028338683



VETRO LOGIC
INTERNATIONAL

INDIA'S OFFICIAL SERVICE PARTNER

Contact Person : **Biswajit Mondal** +91 9867441731

20/B/503, Regency Estate, Kalyan Shil Road,
Dombivli (E), Mumbai - 421 201, India
Email : mondal@vetrologic.com / mondal.personal@yahoo.com



An ISO -9001-2008 company

J.K. International

(An ISO 9001-2008 Co.)

Regd. Off. : 46, New Industrial Estate, Lamba Pind Chowk, Behind Chara Mandi, Jalandhar-144001 Punjab (INDIA)

Unit-I : 18, Industrial Area, Bai Attarian, Kandrori, Distt-Kangra, (H.P), India.

Unit-II : Reru-Dhogri Link Road, Jalandhar (Punjab), Indian.

Phone : 91-78146-53907, 91-93174-53911

E-mail : sales@jkglases.com, jkglases@gmail.com, **Website :** www.jkglases.com



Our Product Range :



Insulating Glass



Bend Glass



Toughened Glass



Laminated Glass



Wind Screens



Decorative Glass

FULL SERIES LOW-E GLASS

BEST FLATNESS TEMPERING



ENERGY SAVING

FOR A BETTER FUTURE



HANGZHOU JINGGONG MACHINERY CO. LTD.
ADD: RENHE, YUHANG, HANGZHOU, CHINA, 311107
TEL : 86-571-88777108
EMAIL : INFO@JINGGLASS.COM
WEB : WWW.JINGGLASS.COM

INDIA OFFICE :
MR. NISHANT CHAUDHARY
MOB.: +91-9873974844